



x2



x2



x1



x12

50 kg

1

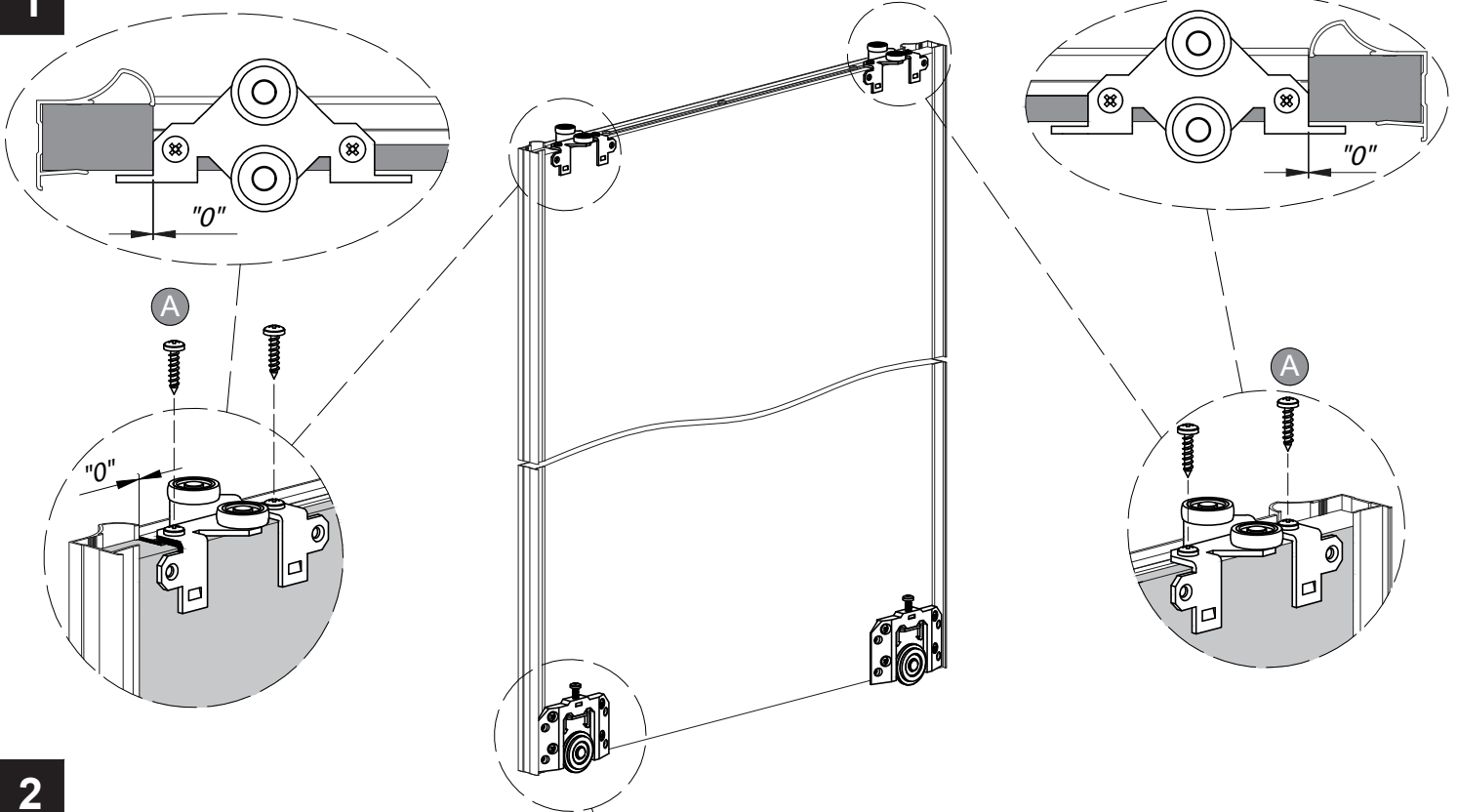

2

