

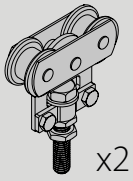

SLID'UP
BY MANTION

INSTRUCTION DE MONTAGE
MONTAGEANLEITUNG
INSTRUCTIONS FOR ASSEMBLY
INSTRUCCIONES DE MONTAJE
INSTRUKCJA MONTAŻU

SLID'UP 1700
SU 1790



x2

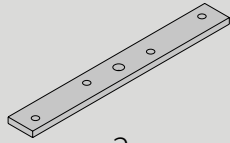

x2

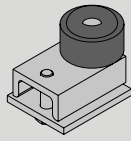

x2

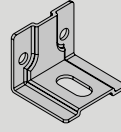

x4

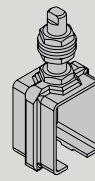

x4

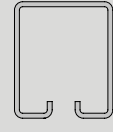

x1



**300
KG**

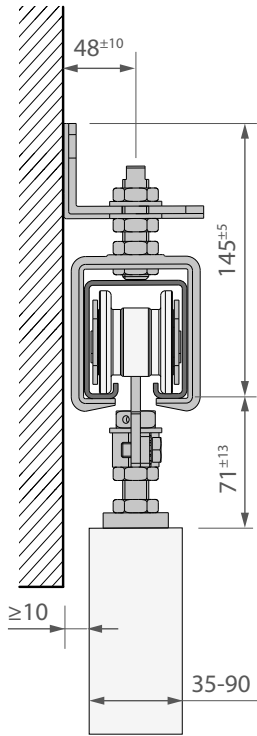

1

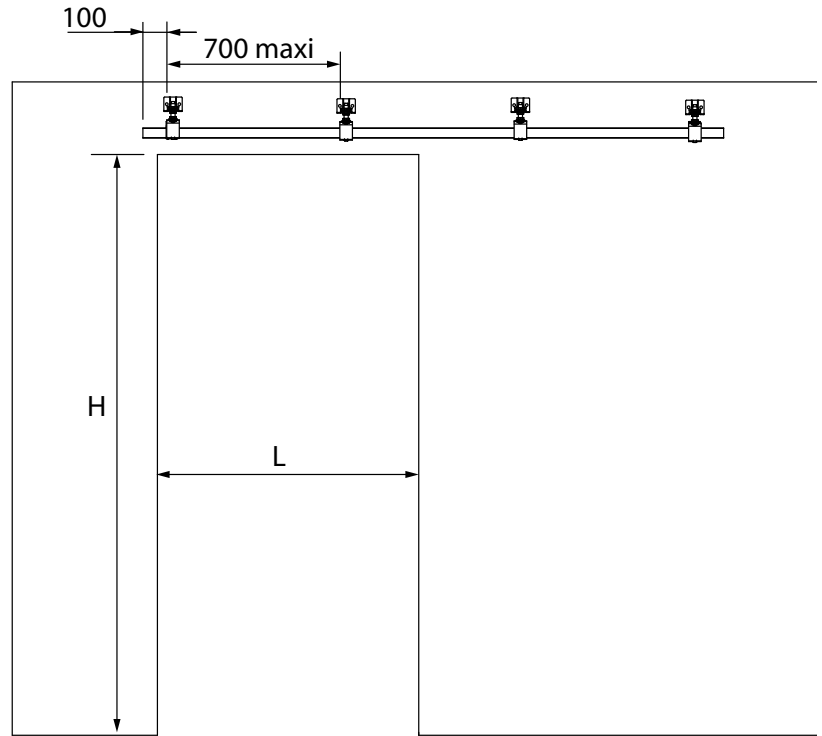

2

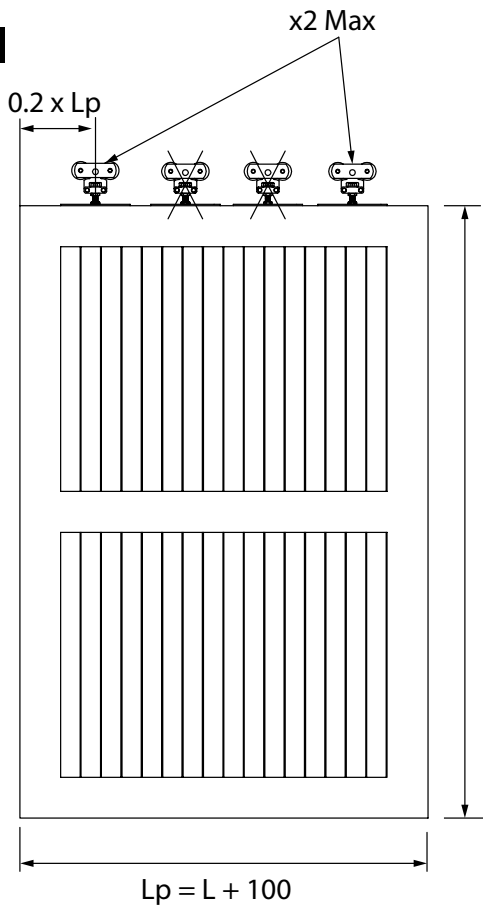

3

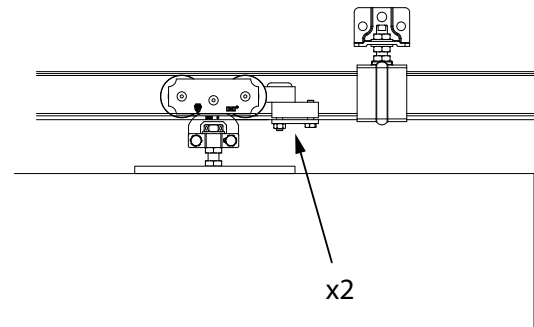

4

OPTION :

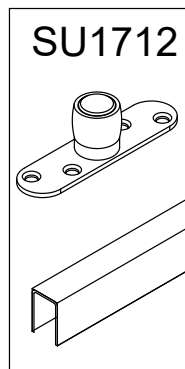

SU1712

