

1

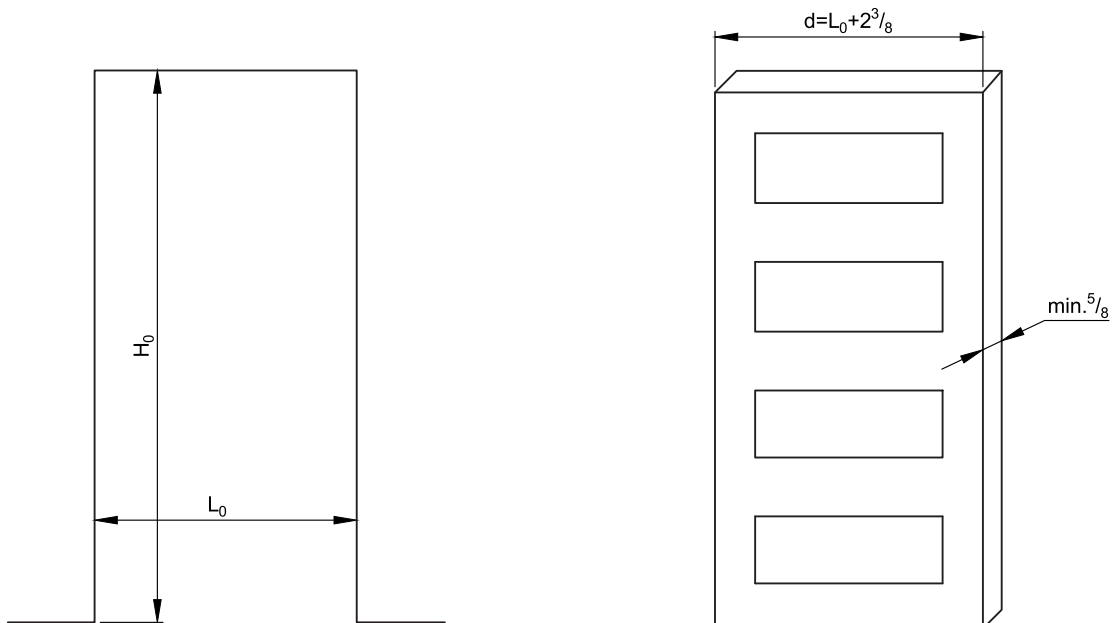

2

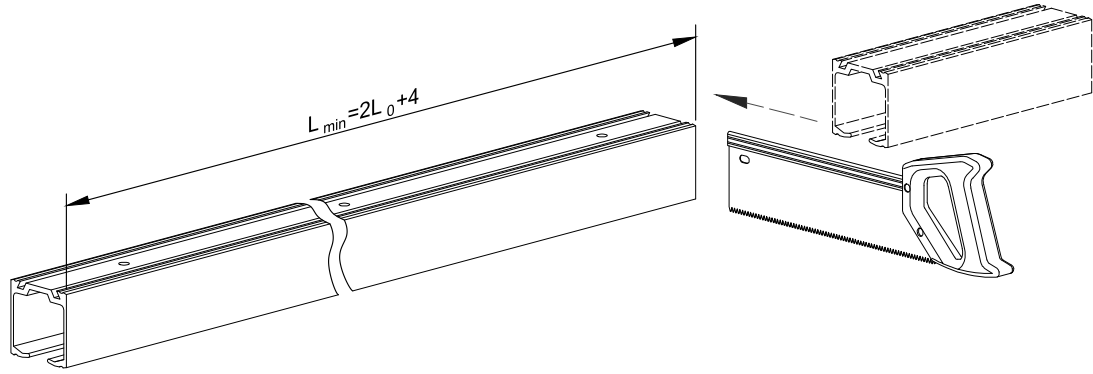

3

L [in]	47	59	70	78	95	118
n	4	4	5	5	6	7

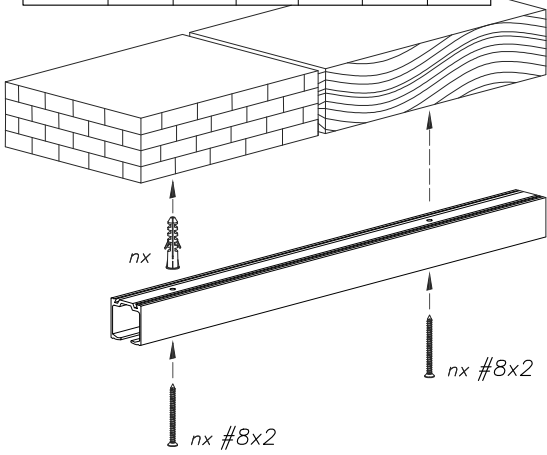

4

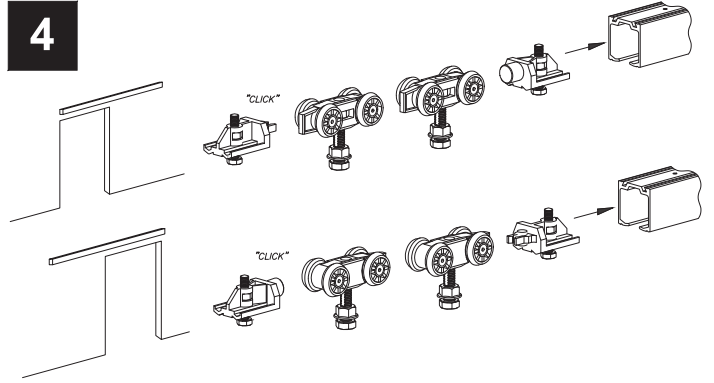

5

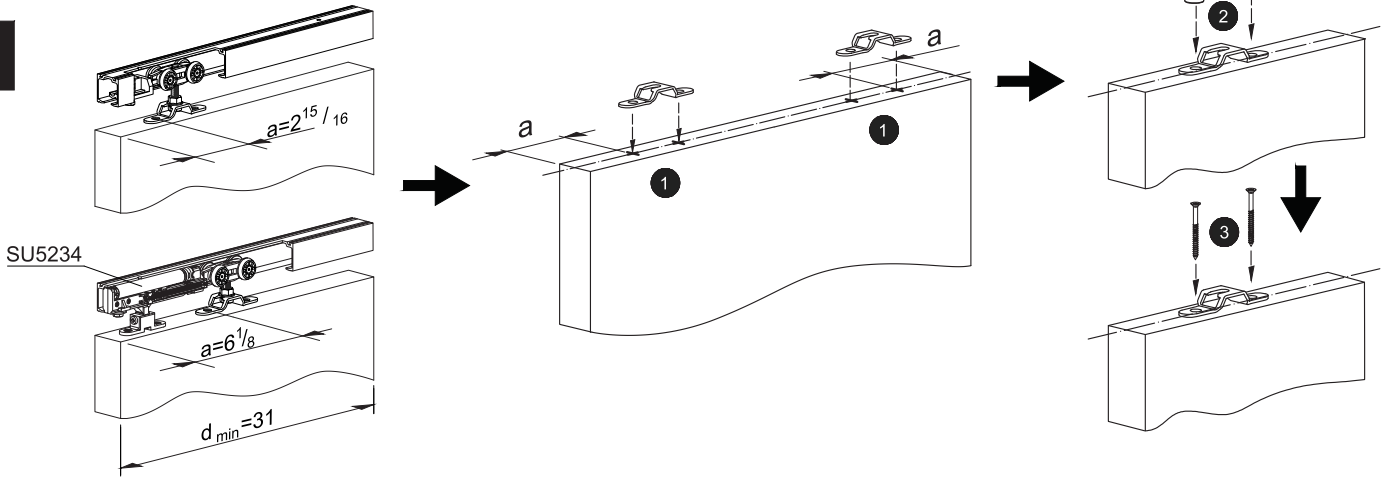

6

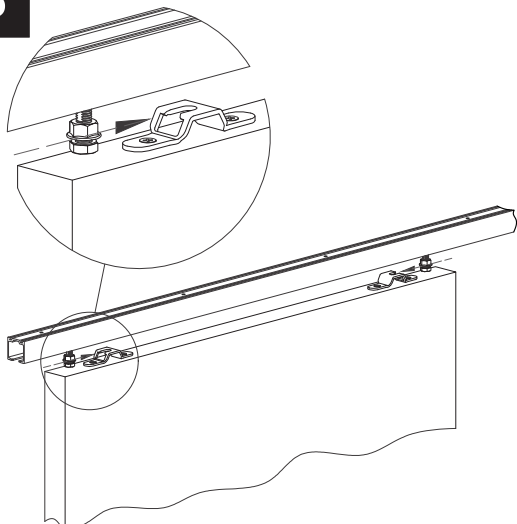

7

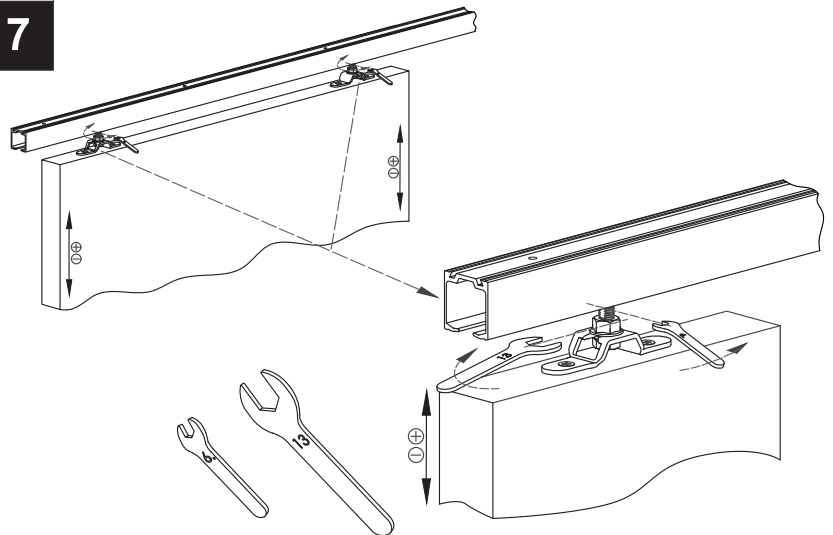

8

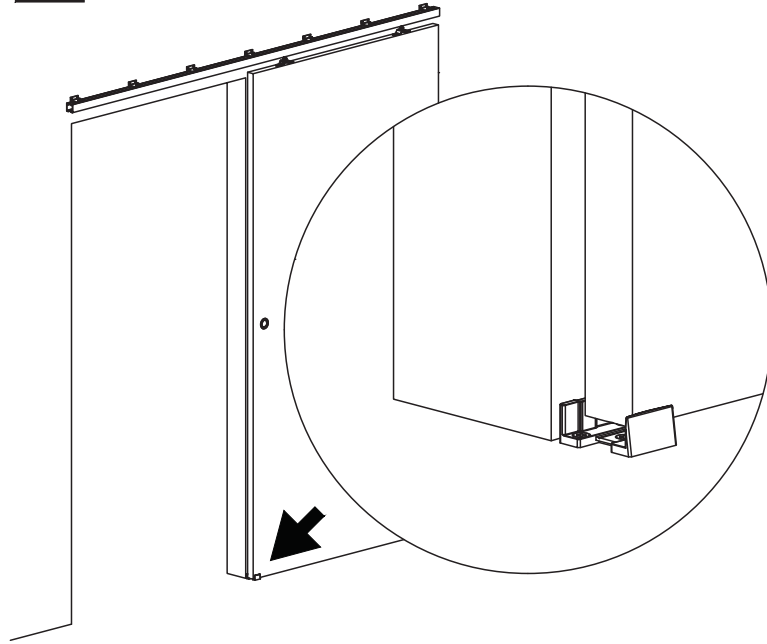

8a

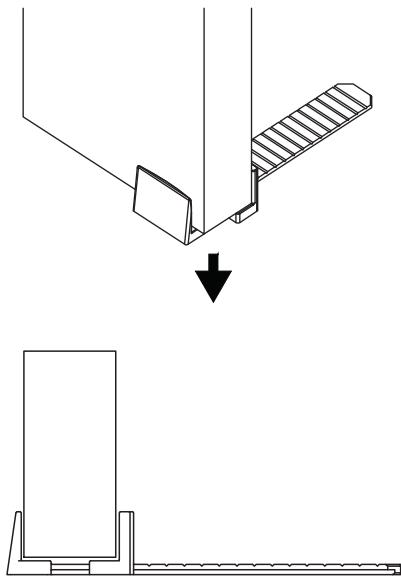

8b

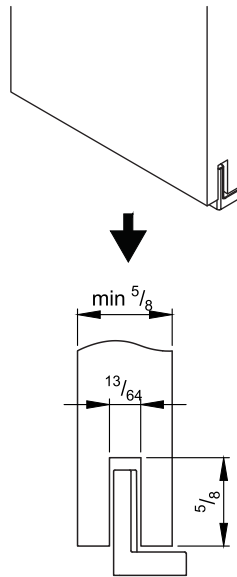

8c

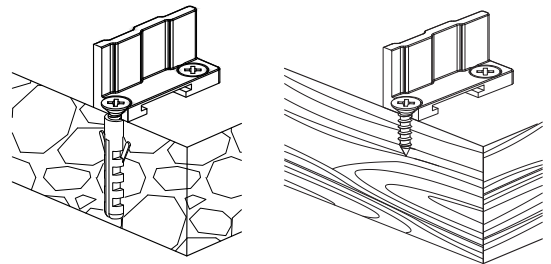
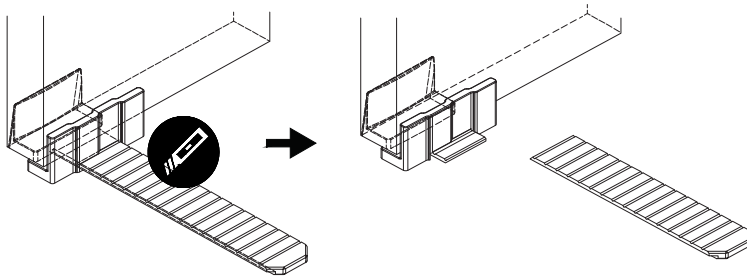
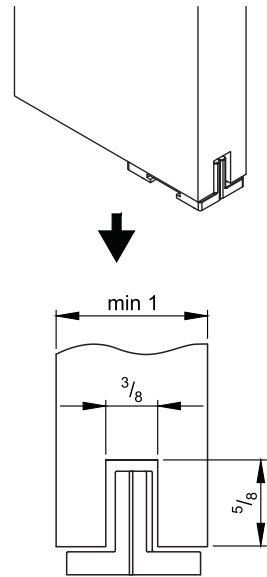

OPTIONS / OPTIONEN / OPTIONS / OPCIONES / OPCJE

a SU5239 (80^{3/4})
SU5240 (120)
SU5233

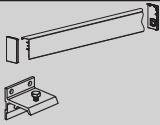
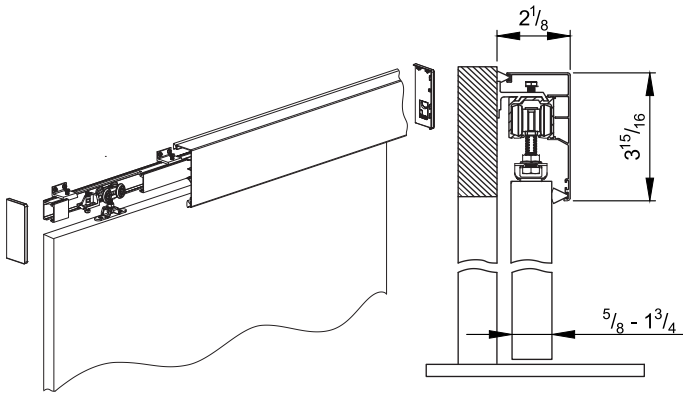

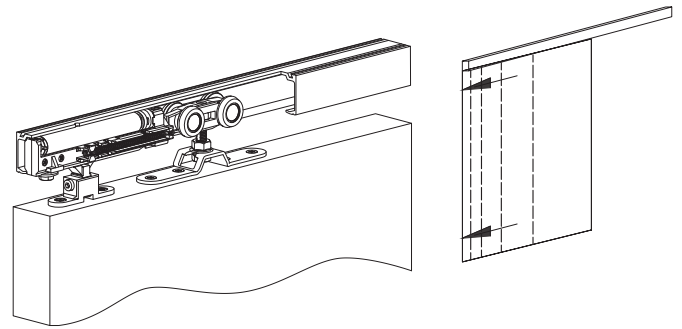

b SU5234

c SU5243

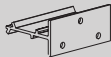
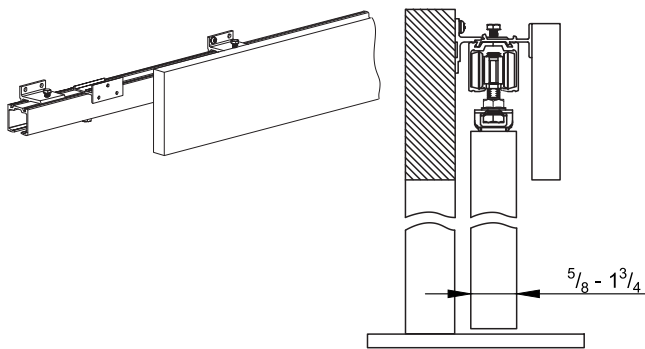
d SU5212  SU5214 - SU5231 

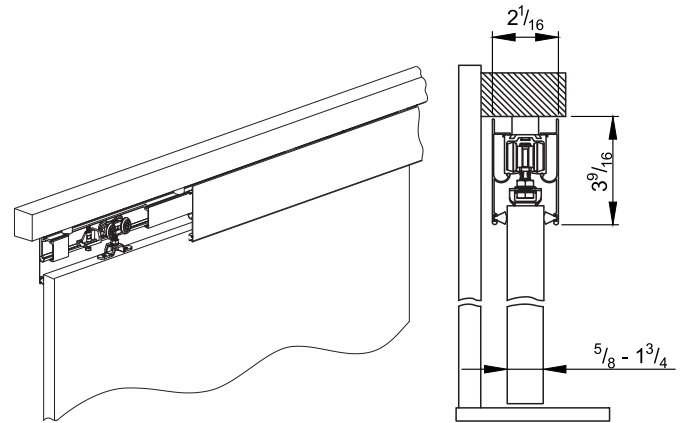

e SU5232 