

SLID'UP
by MANTION

INSTRUCTION DE MONTAGE
MONTAGEANLEITUNG
INSTRUCTIONS FOR ASSEMBLY
INSTRUCCIONES DE MONTAJE
INSTRUKCJA MONTAŻU

SLID'UP 150
SU5123
SU5124



x1

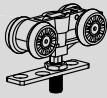

x1

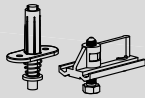

x1

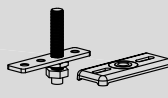

x1

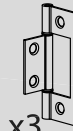

x3



88
lb

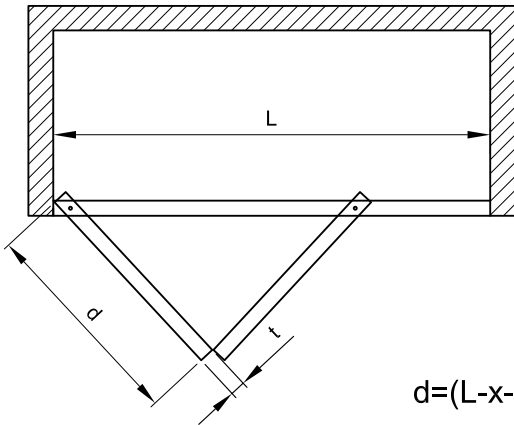

$$d = (L - x - \frac{3}{16}) / 2$$

t [inch]	$< \frac{7}{8}$	$\frac{7}{8}, 1"$	$1\frac{1}{8}, 1\frac{1}{4}$
x [inch]	0	$\frac{1}{8}$	$\frac{3}{16}$

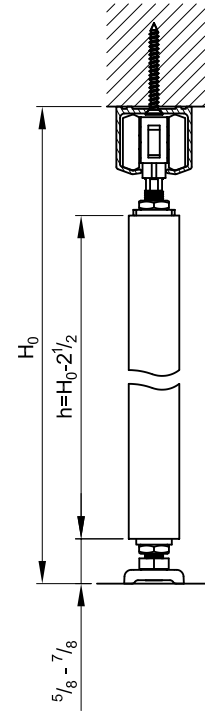

1

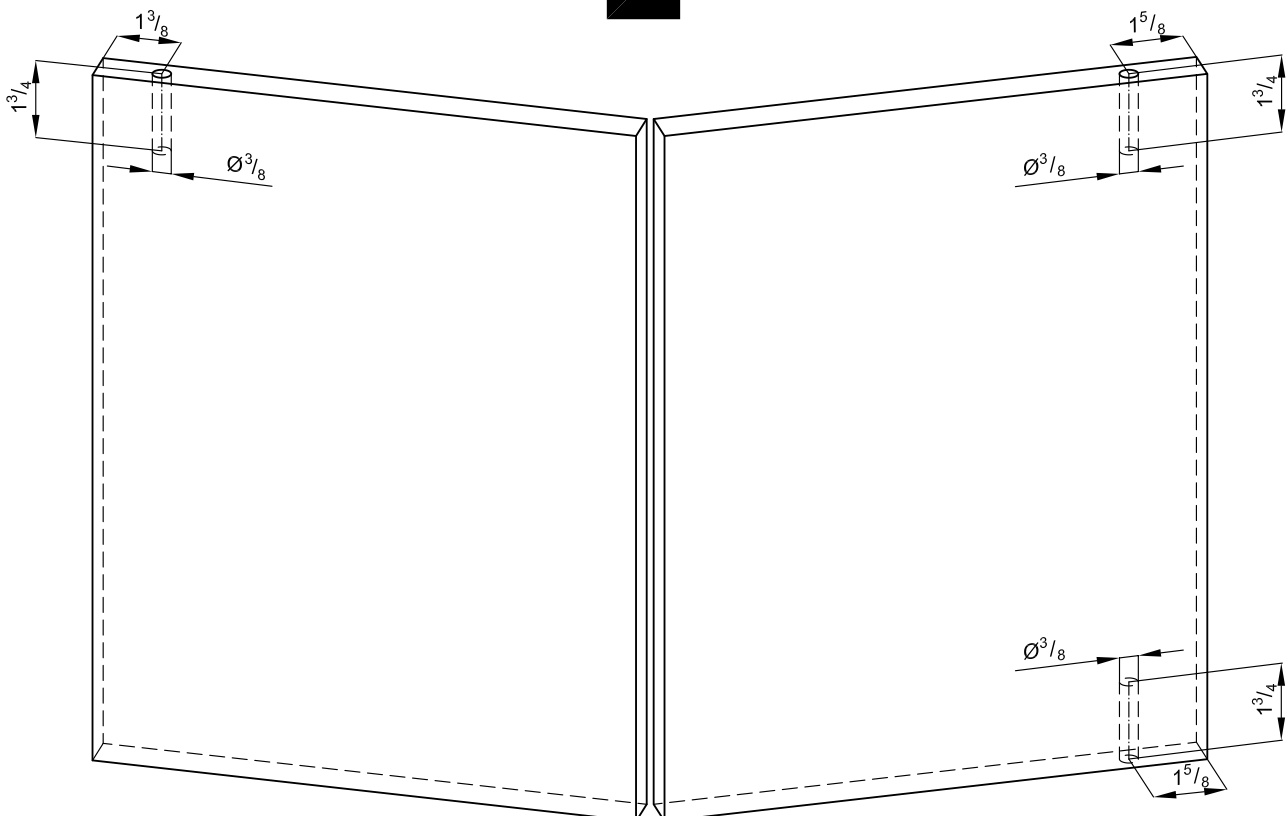

2

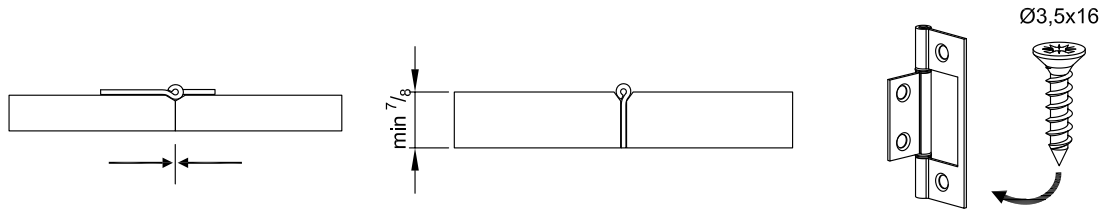

3

